



Hava BoŐluklu Yađmurluk



Filtreli Yađmurluk



Montaj Plakası



19" İ Profil Uygulama



Paslanmaz ya da Alminyum Uygulama

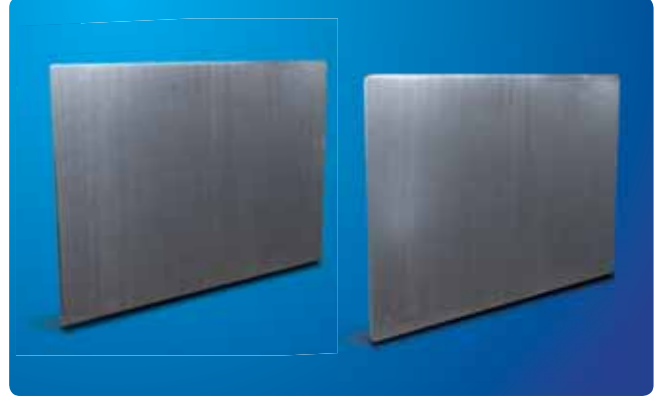

- ▼ 304 yada 316 kalite paslanmaz uygulama yapılabilir Vernik kaplama işlemi önerilir.
- ▼ Alminyum (Almg3) ve zeri boya uygulaması yapılabilir.

H100 mm Veya H200 mm Baza ve Profil Ayak

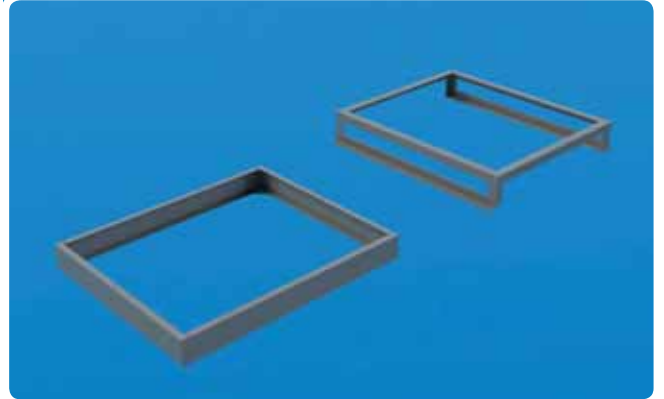

Klima Veya Isı DeđiŐtirici Uygulaması





Materyal : Gövde, arka kapak, alt kapak : 1,50 mm Galvaniz sac + polyester 7035 boya
Çatı : 1,50 mm galvaniz sac + RAL 7012 boya
Ön kapı : 1,50 mm – 2,00 mm galvaniz sac + RAL 7035 polyester boya

IP Koruma : IP 55

Ürün içeriđi : 1 adet ana gövde, 1 adet kapı, 1 adet çatı, 1 adet arka kapak
1 adet süngerli alt kapak

! Gereklİ : Baza ve montaj plakaları için bakınız sayfa 156-157

▼ Teknik çizim için bakınız sayfa 224

▼ İklimlendirme aksesuarları için bakınız sayfa 182-105

Versiyon 1

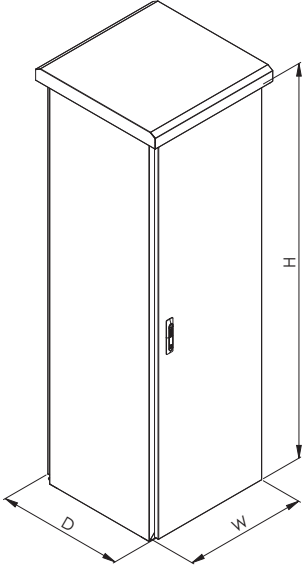

Versiyon 2

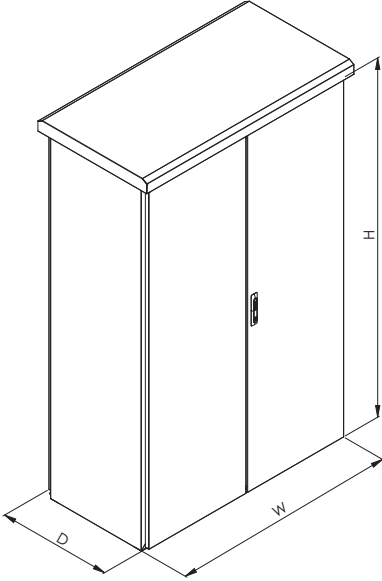

HC KABİN ÖLÇÜLERİ (mm)			REFERANS NO.	VERSİYON
GENİŐLİK(W)	YÜKSEKLİK(H)	DERİNLİK(D)		
600	1100	400	816.114	1
600	1100	600	816.116	1
600	1100	800	816.118	1
600	1600	400	816.164	1
600	1600	600	816.166	1
600	1600	800	816.168	1
600	1900	600	816.196	1
600	1900	800	816.198	1
800	1100	400	818.114	1
800	1100	600	818.116	1
800	1100	800	818.118	1
800	1600	400	818.164	1
800	1600	600	818.166	1
800	1600	800	818.168	1
800	1900	600	818.196	1
800	1900	800	818.198	1
1200	1100	400	812.114	2
1200	1100	600	812.116	2
1200	1600	400	812.164	2
1200	1600	600	812.166	2
1200	1900	600	812.196	2



H100 ve H200 mm BAZA

Materyal : 2,00 mm Galvaniz sac+RAL 7012 boya

Ürün İeriđi : Kaynaklı set baza

HC H100 mm BAZA		
GENİŐLİK (W)	DERİNLİK (D)	REFERANS NO.
600	400	913.164
600	600	913.166
600	800	913.168
800	400	913.184
800	600	913.186
800	800	913.188
1200	400	913.124
1200	600	913.126

HC H200 mm BAZA		
GENİŐLİK (W)	DERİNLİK (D)	REFERANS NO.
600	400	913.264
600	600	913.266
600	800	913.268
800	400	913.284
800	600	913.286
800	800	913.288
1200	400	913.224
1200	600	913.226

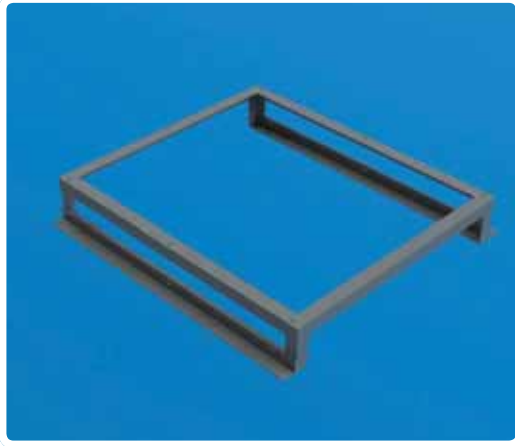

PROFİL AYAK

Materyal : 2.00 mm Galvaniz sac +RAL 7012 boya

Ürün İeriđi : 1 set ayak

HC H300 mm AYAKLI BAZA		
GENİŐLİK (W)	DERİNLİK (D)	REFERANS NO.
600	400	914.364
600	600	914.366
600	800	914.368
800	400	914.384
800	600	914.386
800	800	914.388
1200	400	914.324
1200	600	914.326



FİLTRELİ YAđMURLUK

Materyal : 1,50 mm galvaniz sac+RAL 7035 polyester boya filtre: ABS

IP Koruma : IP 55

Ürün İeriđi : 1 adet yađmurluk, 1 adet 150x150 mm veya 250x250 mm filtreli havalandırma, 1 adet üst akıntı parası ve bađlantı paraları

Referans No : 150x150 mm filtreli iin: **983.121** (1 Adet)
250x250 mm filtreli iin: **983.122** (1 Adet)



HC MONTAJ PLAKASI

Materyal : 2,00 mm Galvaniz sac

Ürün İçeriđi : 1 adet montaj plakası

! Gereklİ : Montaj plakasının takılabilmesi için montaj plakası hareket raylarına ve kızaklarına ihtiyaç vardır. Kabinin derinliđine uygun seçim için bakınız sayfa 113, 115-119

HC KABİN ÖLÇÜLERİ mm		
GENİŐLİK (W)	YÜKSEKLİK (H)	REFERANS NO.
600	1100	942.562
600	1600	942.566
600	1900	942.569
800	1100	942.582
800	1600	942.586
800	1900	942.589
1200	1100	942.522
1200	1600	942.526
1200	1900	942.529



HC 19" İÇ PROFİL UYGULAMA

Materyal : 2,00 mm DKP sac + çinko kaplama

Ürün İçeriđi : 600 mm ve 800 mm genişlik panolarda 1 set (4 adet) profil.
1200 mm genişlik panolarda 2 set (8 adet) profil

! Gereklİ : SipariŐte kabin derinliđi belirtilmelidir.

HC KABİN ÖLÇÜLERİ mm			
GENİŐLİK (W)	YÜKSEKLİK (H)	UNIT (U)	REFERANS NO.
600	1100	22	944.961
600	1600	33	944.966
600	1900	40	944.969
800	1100	22	944.981
800	1600	33	944.986
800	1900	40	944.989
1200	1100	22	944.921
1200	1600	33	944.926
1200	1900	40	944.929

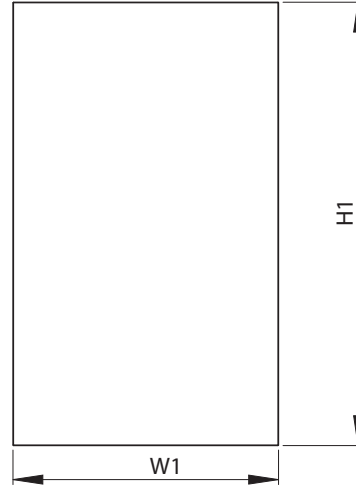
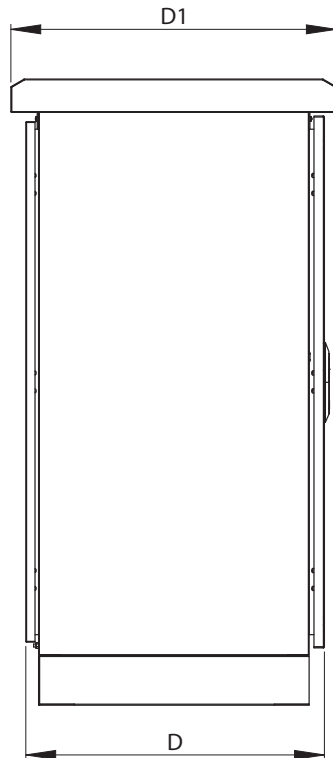
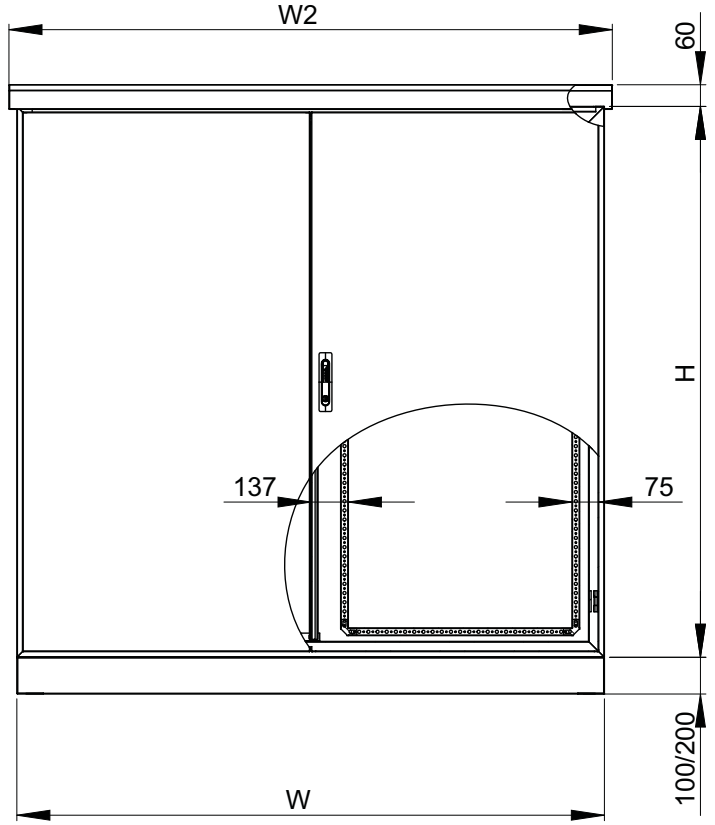
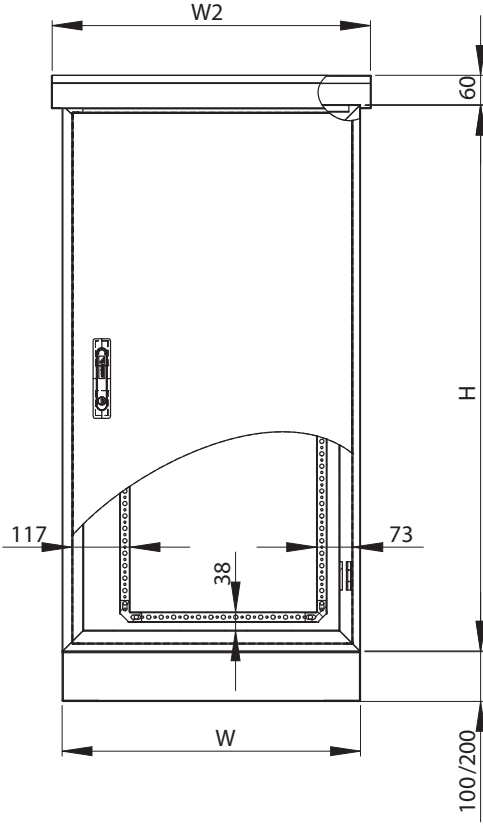

PANO GENİŞLİK	W	W1	W2
600	600	498	640
800	800	698	840
1200	1200	1098	1240

PANO DERİNLİK	D	D1
400	400	454
600	600	654
800	800	854

PANO YÜKSEKLİK	H	H1
1100	1100	984
1600	1600	1484
1900	1900	1784



ENDÜSTRİYEL PANO VE KABİN

Ankara Asfalt 14.km İstiklal Mh. 17.Sk. No:8

Ulucak / Kemalpaşa / İzmir

Telefon : +90 232 877 18 77 - 877 13 46 / 47

Faks : +90 232 877 13 48

E-mail : info@tekpan.com.tr

Yurt İçi Satış : satis@tekpan.com.tr

İSTANBUL BÖLGE SATIŞ OFİSİ:

İmes San.Sit. A Blok 101 Sk. No:36 Y.Dudullu / Ümraniye

İstanbul

Telefon : 0216 526 58 46 / 48

Faks : 0216 526 58 42

E-mail : tekpanistanbul@tekpan.com.tr



www.tekpan.com.tr

